

1730

MAXIMUS™ HD
LIGHTWEIGHT COMPOSITE

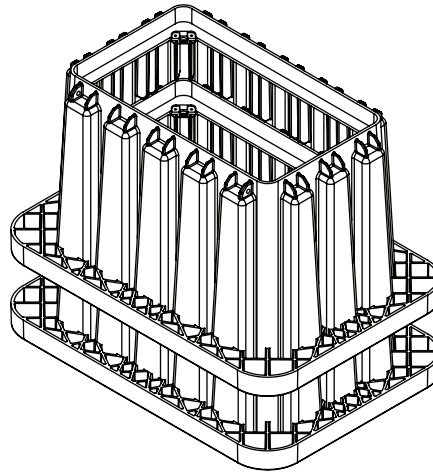
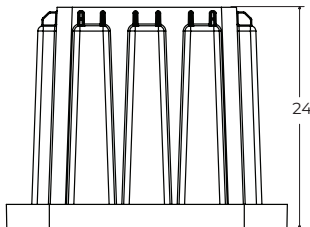
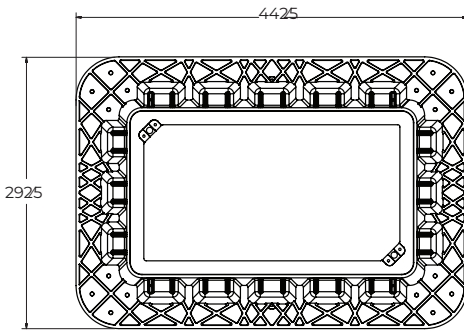
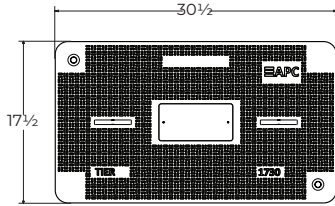

All bodies are rated to ANSI/SCTE Tier 22. Overall performance for a unit—defined as a body and cover with bolts—is determined by the lowest-rated component.

BOLT OPTIONS

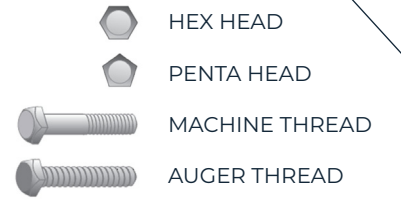

PRODUCT OPTIONS AND ACCESSORIES

- + Knockouts, Mouseholes, and Conduit Entries
- + Cable Racking
- + Dividers
- + EMS Locators
- + Specialty and Security Hardware
- + Grounding and Bonding Accessories

MARKING OPTIONS

When it comes to marking plates, **your standard is our standard.** Custom markings and artwork are a breeze to customize your enclosure. Connect with our team for more information on markings.

PRODUCT TYPE	NOMINAL SIZE	PERFORMANCE	PART NUMBER	APPROXIMATE WEIGHT
Unit	17" x 30" x 24"	Tier 15 and Tier 22	CH173024U2200HA	90 lbs.
Box	17" x 30" x 24"	Tier 22	H173024B22	67 lbs.
Cover	17" x 30"	Tier 15 and Tier 22	C1730XXC2200	23 lbs.

Part numbers listed in the table are for standard boxes without accessories. Covers and unit part numbers are for marking plate required covers and units that have a blank 4" x 8" recess to accept a marking plate. Units listed above have hex head, auger thread hardware as standard.

APC PRODUCTS MEET OR EXCEED THE FOLLOWING STANDARDS AND GUIDELINES:

- + Build America, Buy America (BABA)
- + ANSI/SCTE 77 2023
- + Telcordia GR-902-CORE
- + Western Underground Committee Guide 3.6



The materials and information in this document have been prepared by American Polymer Company for informational purposes only. American Polymer Company reserves the right to make changes or improvements to the products described in this document at anytime without notice. Revision Date: 02/2024

© American Polymer Company

1-888-411-3048

apcunderground.com