



**BUILDING
TECHNOLOGY**



AUGUST 2023



WE'RE DRIVEN TO GET THE JOB DONE.

NSI has been helping contractors get tough jobs done since 1975. With professionally-preferred products at competitive prices and service you can count on in the field, we're the partner you need to be successful.



VALUE PROPOSITION

National footprint

- 200k+ square feet of nationwide warehousing with locations in CA, OH & PA
- Engineering & sales locations in CA, OH, PA

Dedicated sales resources

- Inside account management & customer service team, outside regional sales managers & independent rep agency support

Demand creation

- Aggressive outbound marketing & spec creation with end-users and integrators

Product innovation

- Active & pending patents for connectors, tools, cables & infrastructure solutions

Industry-leading brands

- NSI Building Technology is your infrastructure solution partner

BRANDS



Trusted Since 64. LYNN has been servicing the communications industry with an unmatched dedication to integrity, quality and commitment to customers since 1964.

ThinkLynn.com



Cut. Strip. Terminate. Test. Platinum Tools has been helping low-voltage professionals get tough jobs done since 1997.

PlatinumTools.com



Simplify fiber optic & audio-visual installations. TechLogix delivers innovative, value-rich solutions while simplifying the design and integration of AV, security and datacom technology.

TLNetwork.com



Professional Quality Tape. Whether you are bundling, insulating, splicing or simply need protection against corrosion, UV or moisture, WarriorWrap® outperforms whatever tape you've been using.

NSIIndustries.com

STRATEGIC PRODUCT CATEGORIES

Cable Management

- Consumables
- Fiber Management
- Enclosures
- Installation Accessories
- J-Hooks
- Patch Panels & Rack Trays
- Weather-Rated Installation

Cabling

- Audio-Visual Cables
- Bulk Cable
- Connectors
- Consumables
- Custom Assemblies
- Patch Cords

Connectivity

- Adapters & Couplers
- Keystones & Keystone Mounting
- Splices, Sleeves & Trays
- Splitters

Electronics

- Audio-Visual Extenders
- Networking

Power

- Power Cords

Tools & Testers

- Bags, Pouches & Cases
- Connectivity & Measurement
- Crimpers
- Cutters
- Fiber Cleaning
- Fiber Termination
- Hand Tools
- Punchdown
- Screwdrivers
- Strippers

CUSTOM CABLE ASSEMBLIES

LYNN



Fiber Cable Production

- TAA & Buy American Act compliant product
- Any length & configuration
- Corning™ Gold assemblies
- Quick turn customized solutions



Copper Cable Production

- TAA & Buy American Act compliant product
- Any length & configuration
- Quick turn customized solutions



Off-Shore Cable Production

- Leveraged for high-volume & price competitive projects
- 2–3 week turn times
- Stocked inventory in CA, OH & PA



LYNN specializes in custom fiber and copper cable assembly manufacturing with facilities on the East and West coasts. Built in the USA in as little as 48 hours.

3 sizes: 144, 288, and 576 (single fusion numbers)

KISS: Keep it simple approach

- Water is our enemy
- Ports are 100% waterproof until cut
- Time tested heat shrink with gel approach for water sealing used port

Included

- Grounding equipment
- Large slack storage tray



576 Splice tray

- One Part number includes everything you need
 - QTY 6: 12 fiber single fusion chips
 - QTY 6: 6 ribbon fusion chips
 - QTY 2: Splitter holder chips
- Splice chips will work in CommScope units
- The splice trays will snap into a CommScope FOSC that accepts D sized trays

Stock only one SKU!!
C Tray coming end of June

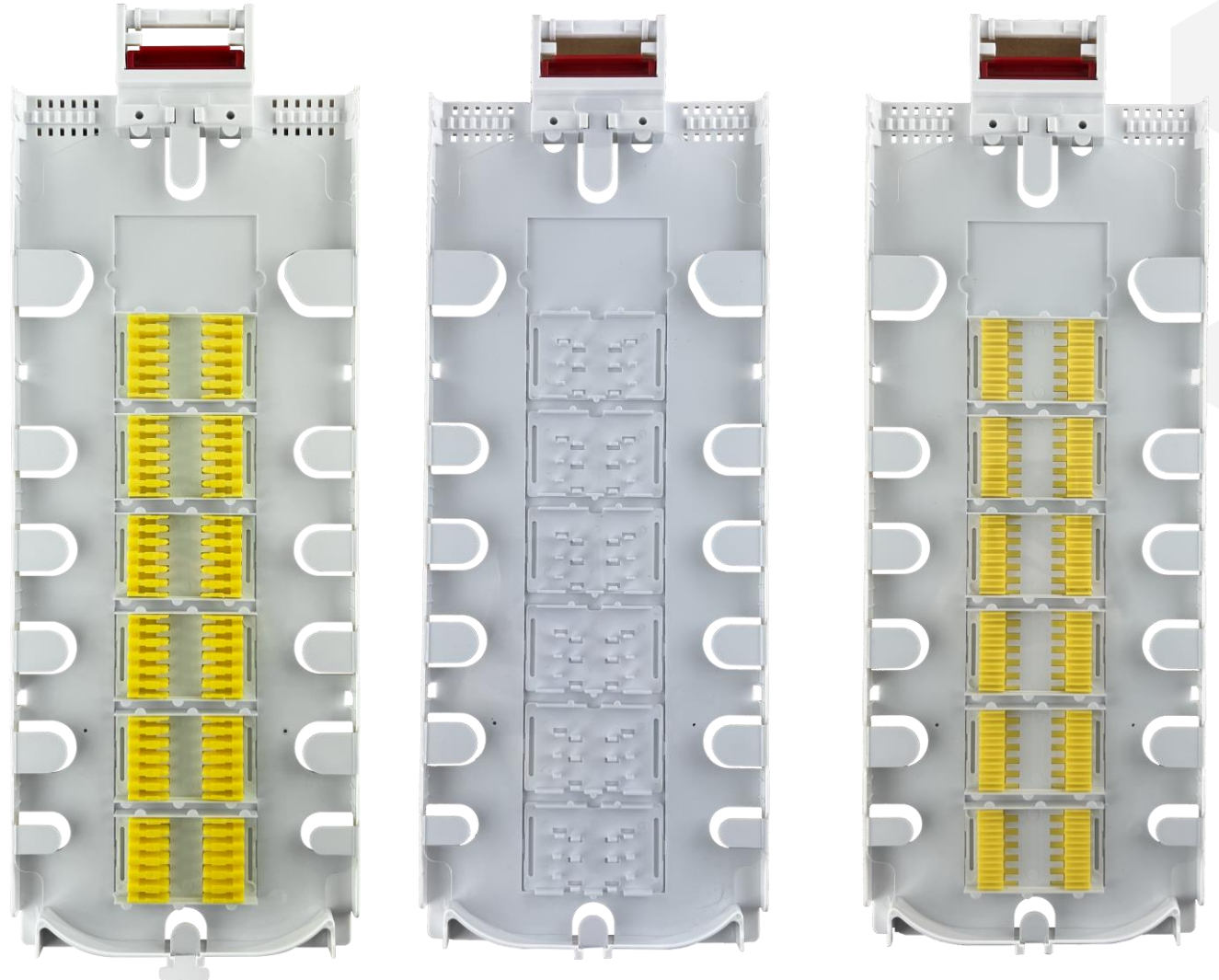

144 and 288 Splice trays

- One Part number includes everything you need
 - QTY 2: 12 fiber single fusion chips
 - QTY 2: 6 ribbon fusion chips
 - QTY 1: Splitter holder chips
 - Same splice chips used on the 576
- The splice trays will snap into CommScope FOSCs that accept A/B sized trays

Accessories

- Wall Mount, Pole mount, and Aerial kits are universal to all three sizes



Up to 1 inch conduit | 5 different versions | Up to 12 fiber splicing | Universal clamp



Thru-hole Cable Entry Clamp Designed for Round or Flat Dwg. Cables



Copper Bonded Lug Included



Lugs Spacing Increases Easy for up to 1/2 inch Conduit



Splice

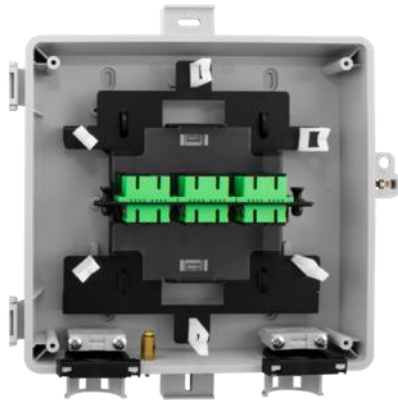

LGX



Patch



Hardened



ONT



Available Preloaded

- Reduce labor costs and speed deployment

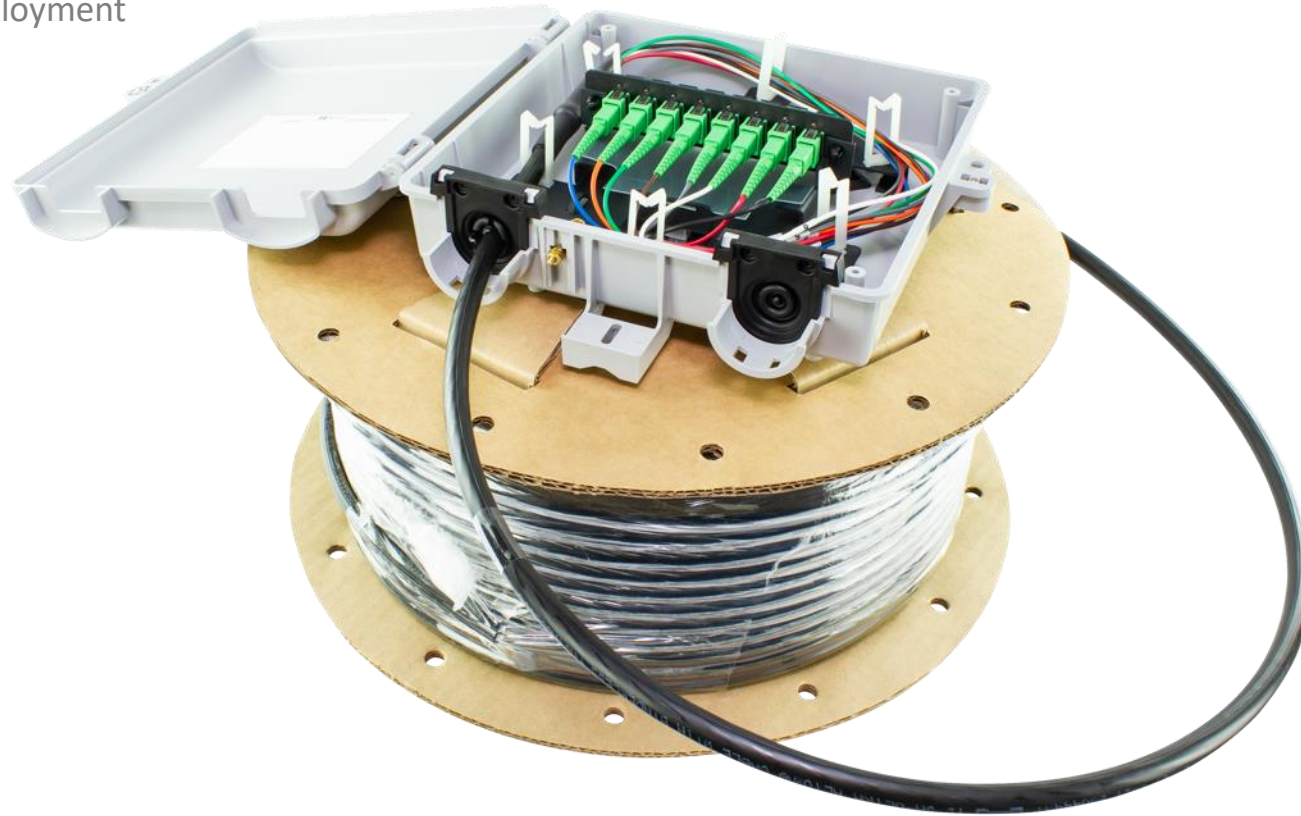

COMPACT NID

LYNN



- Entry level price with most the features you need
- New update will let you have a 1-inch conduit
- Private label available



OTHER NIDS

16 port

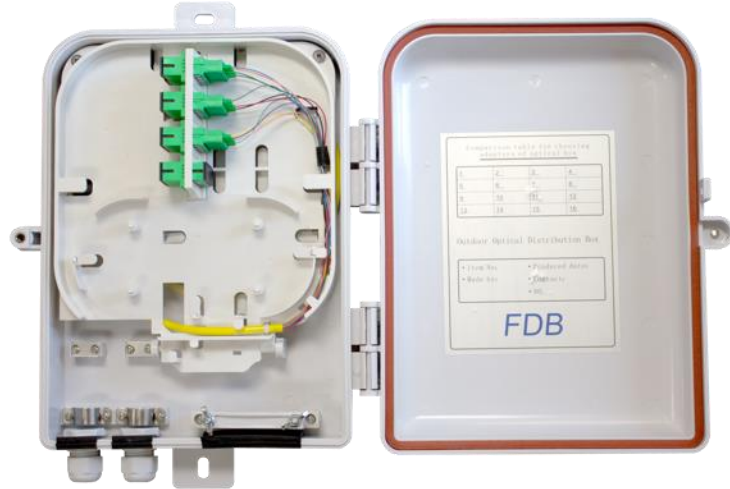

24 port

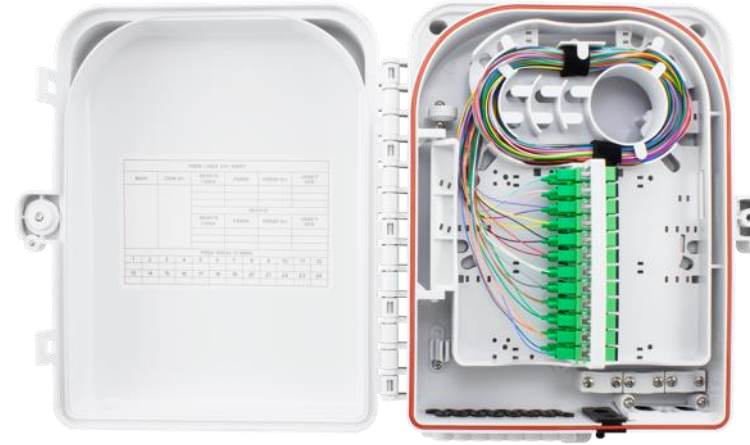

Accommodates 2.0 mm, 3.0 mm pigtail, or drop cable

Includes Female OptiTap Compatible connectors

- Allows you to plug in standard OptiTap Flat drops

Splitters can be preinstalled: 1x2, 1x4, 1x8, 1x16

Can do HMFOC input for Multifiber needs

Available in 2, 4, 6, 8 and 16 port

Small and flexible

Faster delivery compared to MST with pigtailed

Perfect for both PEDs and Vaults



- OptiTap Compatible
- Available in 2, 4, 6 and 12 fiber/port
- Separate molds for 2, 4, 6, and 12

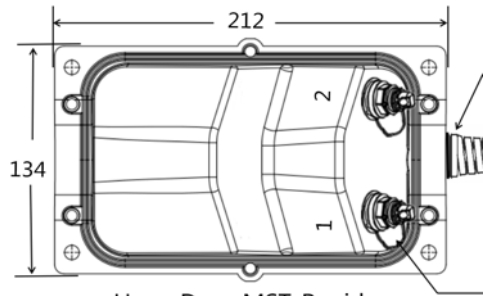

HyperDrop MST-Rapid

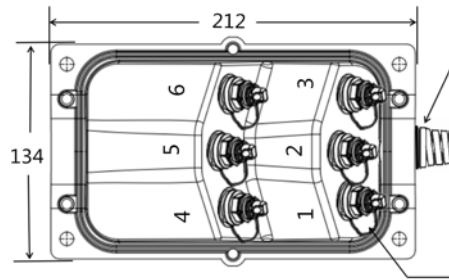

HyperDrop MST-Rapid

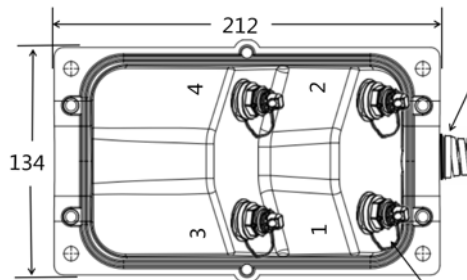

HyperDrop MST-Rapid

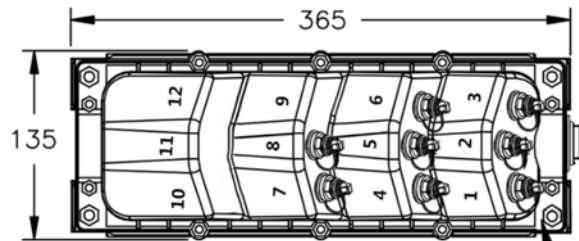

HyperDrop MST-Rapid



THE BEST FLAT DROP EVER

Easily Peelable with a Jonard FOD-2000 tool

3mm rugged cable inside

- Take off excess flat drop and store in a NID or PED

Double O-Ring on OptiTap for better water protection

Stocking many toneable sizes, OptiTap to SC APC



LIFESAVER

LYNN

NSI
BUILDING
TECHNOLOGY

No reel now needed to be included with Flat Drops or Hyperdrop MST product

- Reduce waste/trash
- Reduce shipping costs
- Designed for this purpose thus more efficient and faster deploy



CommScope Crosses:

- OFDC when it is just drop cable coming in
- OTE with the OptiTap compatibles

Splitters can be preinstalled: 1x2, 1x4, 1x8, 1x16

Midspan and standard cable entry points

Available in 4, 6, and 8 port OptiTap compatible

Available in 16 port round and flat drop (flat drop cannot be pre-connectorized)

Can handle up to a 144 armored cable coming in

Splice up to 48 single fibers

Air pressure port to test for possible water leakage



CommScope Crosses:

- OFDC when it is just drop cable coming in

Splitters can be preinstalled: 1x2, 1x4, 1x8

Midspan or used standard cable entry points

Available in 8 port round and flat drop (flat drop cannot be pre-connectorized)

Can handle up to a 144 armored cable coming in

Splice up to 12 single fibers



Fits in a smaller vault!!

The world's most complete indoor FTTx solution!

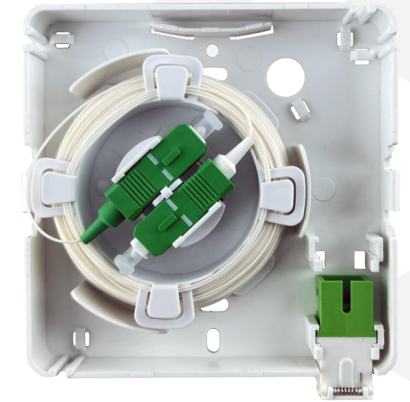
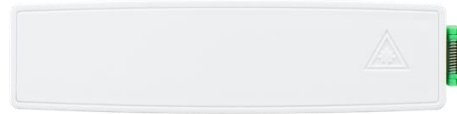

All products are finished in the high gloss white and match!

- Fast install directly to single gang box
- Slack storage
- Multiple fiber patch/splice
- High-end gloss finish



- Made for Duplex needs
- Includes front cable protection
- Built in splice tray
- Overall design is compact



- Surface mount box for fiber
- Designed for MDUs and cubicles
- 3 mm jacket fits snugly

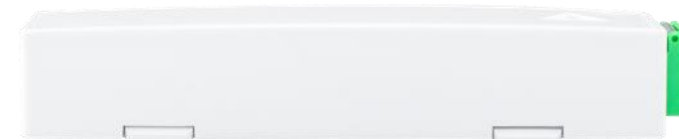
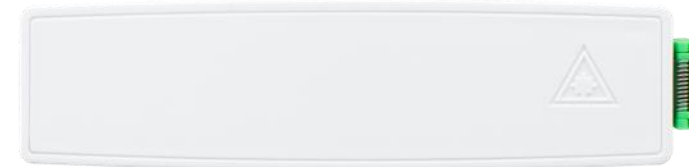

SlimFIT™ ONT



P/N: FPP-01-W-A9



Adtran® (411 and 611)

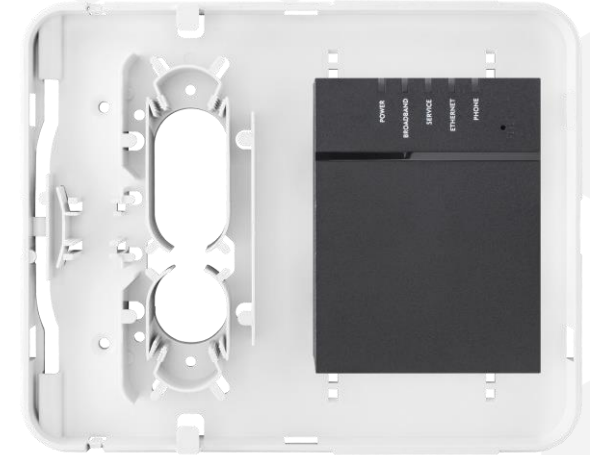

Calix (803G)

Supports popular ONTs

Designed for Adtran® (411), Calix (803G), and Ubiquiti® (U FIBER). Custom mounting plates available for other ONTs.

Sleek Design

Your customers won't know it's there ... no more customer meddling.

Slack Storage

Easily store excess cable inside enclosure.



Ubiquiti® (U FIBER)

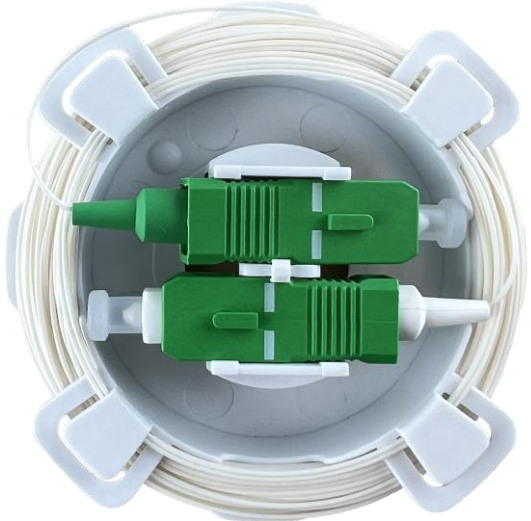
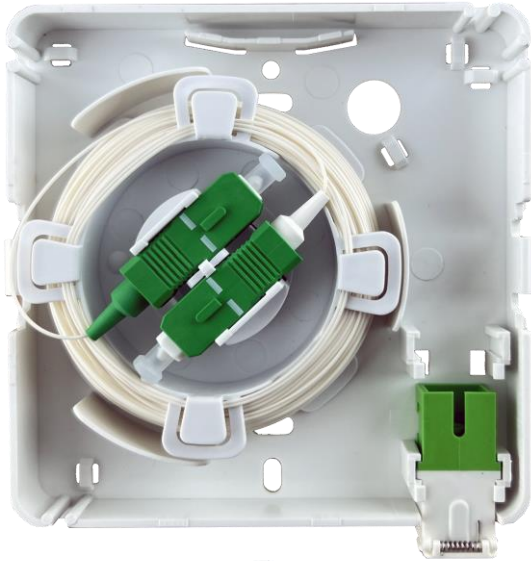

30 Meters of 600um on reel
Includes a tool and accessories to pull through wall
and protect around corners and wall entry

Tool: Used to push through wall

- Designed for 900um boot on one side and other side 2/3mm boot



- Extremely thin compact design
- Will allow copper and fiber in one plate (Game Changer)
- Perfect to use with SlimFit MDU solution
- SC Automatic internal shutter





splicious . /spliSHəs/

1. having or providing a ridiculously large splicing area and storage in an itty-bitty space

- Front and rear entry points
- Built-in cable management
- 72 SC fiber every 1U (108 LC)



Front entry



Rear entry



Built-in waterfalls



Large splicing area



Hinged front cable management



- All FRONT entry
- Installs on pole or pad
- 864, 576, 288, and 144 port options
- Preloaded with outdoor ruggedized splitters
- Painted stainless steel
- Vented top



Fiber Rapid Deployment Panel

- Specifically designed to quickly install into a rack while having a supported trunk cable coming out the back
- Great for turning cabinets into Splitter Cabinets

144 3U and 288 6U SC versions

- Loose tube, Ribbon, armored OSP cable available

Shallow depth – Flexible design fits into a variety cabinets

- Front cable manager to back is less than 13 inches

Will stock finished, loose tube 144 units in the future, with 150FT tails

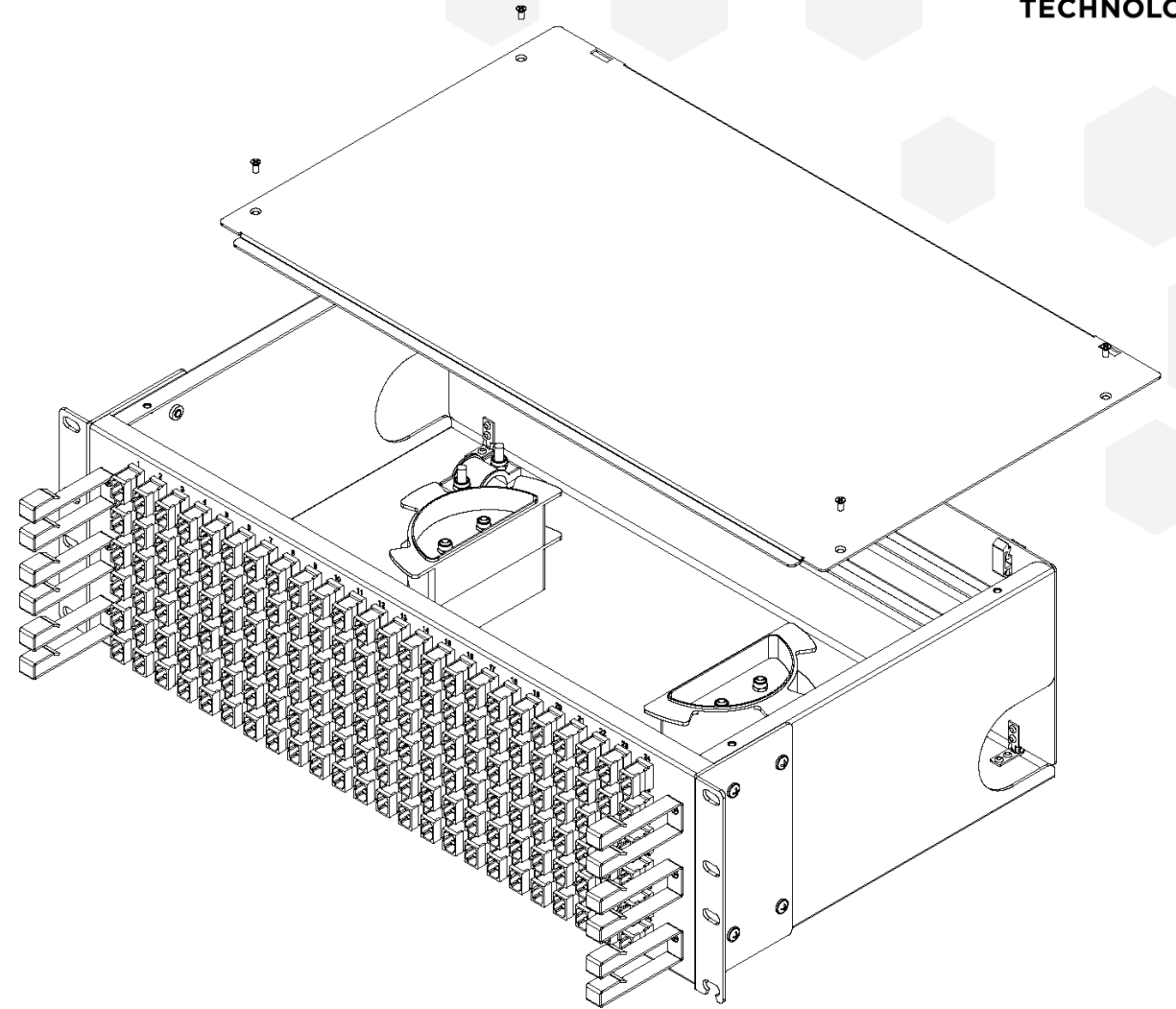

- Made to be used with FRD Panels
- Holds Rugged or ABS splitters like book ends
- Install LGX adaptor plates or Splice Cassettes for feeder cable

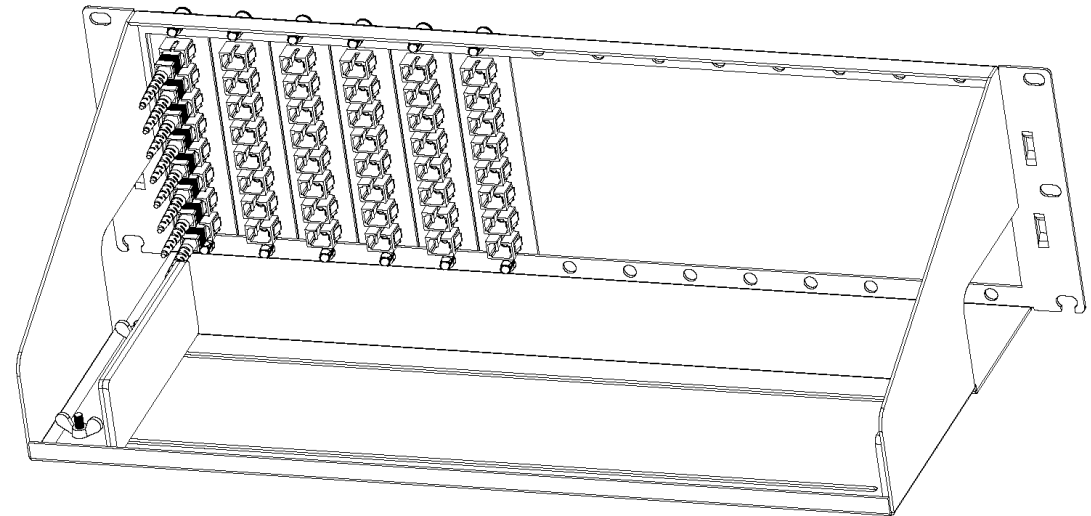
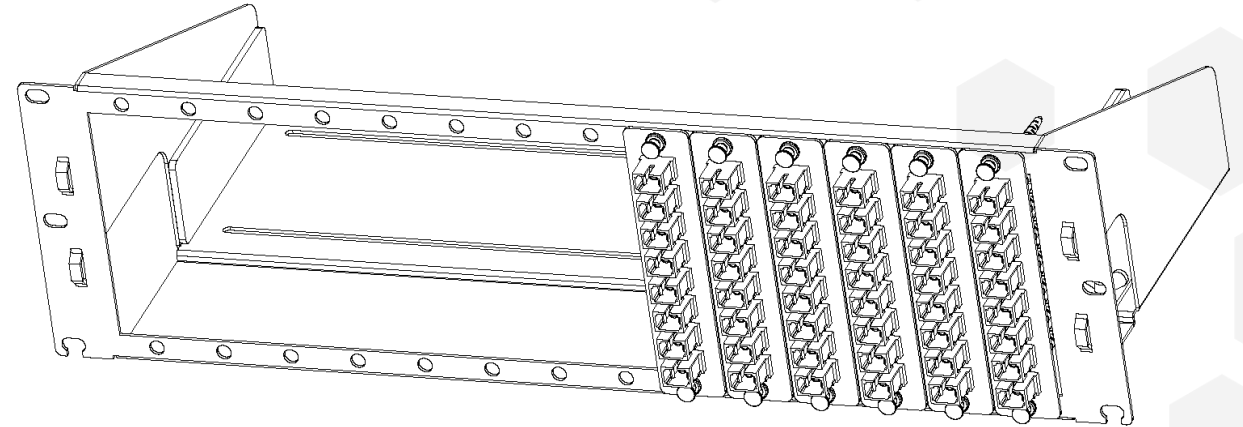



- Compact design
- Factory terminated pigtail
- Rugged design for outdoor enclosures, pedestals, and racks

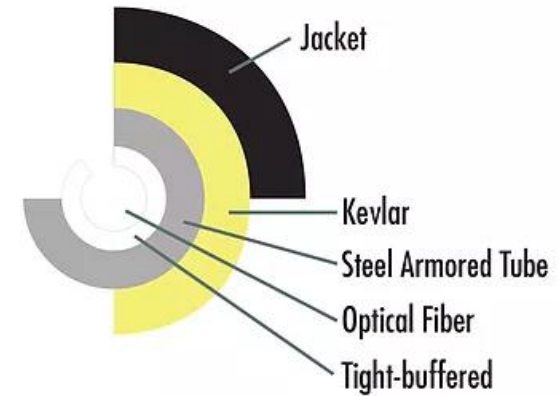

The Giant – 14 LGX

Removable Inner Core

Twin – 2 LGX



Hex – 6 LGX



Bubble level for easy installation



Non-captive entry points



Dual hinged enclosure for easy access

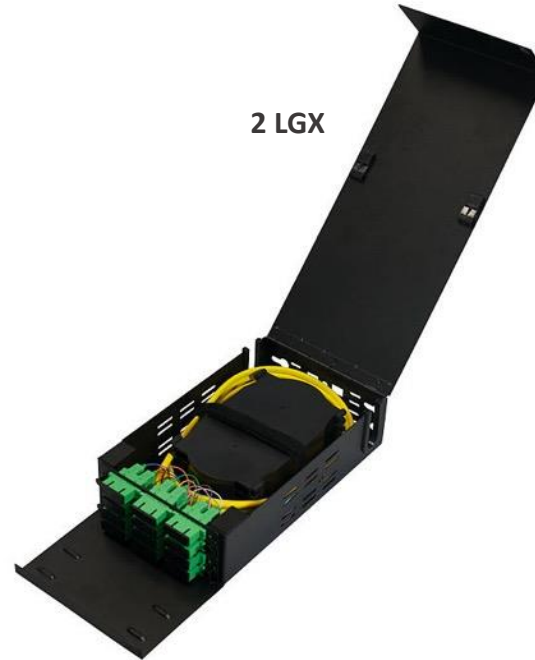

- Available preloaded and pre-terminated
- Supports LGX adapter plates or MPO cassettes
- Popular wall mount splicing solution

- Grommeted non-captive entry points
- Sturdy steel construction
- Easy release latches



RUGGEDIZED SPLITTERS



Compatible with FieldSmart® FSC OSP Cabinets Platform (Clearfield® WaveSmart Ruggedized Splitter)



Compatible with Charles Industries CFFP Platform (CFSM-FP Splitters)

Channel Version Available



- Rack mount and LGX
- Customized for your application

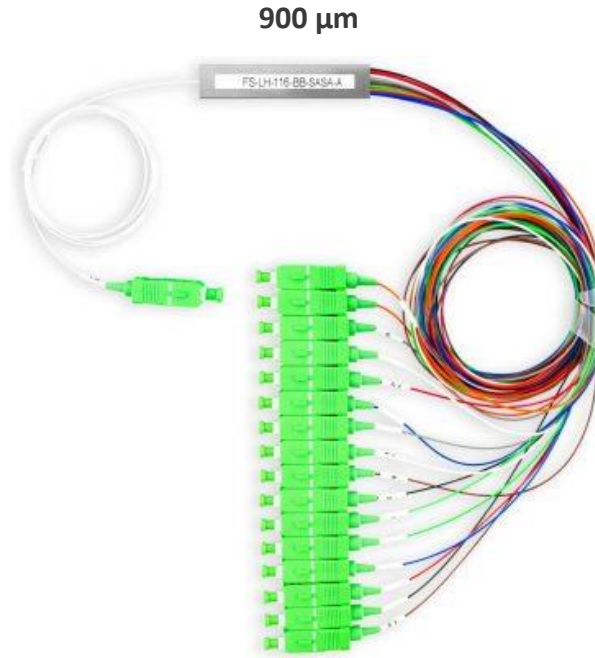

- PLC mini-modules
- FBT (dual and tri-window)



RUGGEDIZED CABLES

Pushable fiber



Ruggedized fiber



Armored fiber



Flat drop fiber



Ultra-flexible

Armored Internal Construction

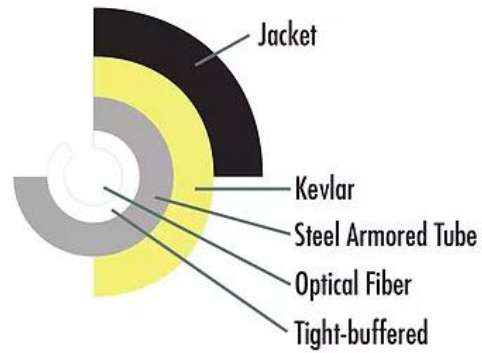



Pushable/Pullable Bullet Fiber

- Pre-terminated stock and custom lengths
- UV & water-resistant outdoor jacket
- Added rigidity to eliminate kinks when pushing & pulling through ¼" holes or larger
- Internal steel micro-armor for protection from abrasion, cutting & rodents



Armored Internal Construction

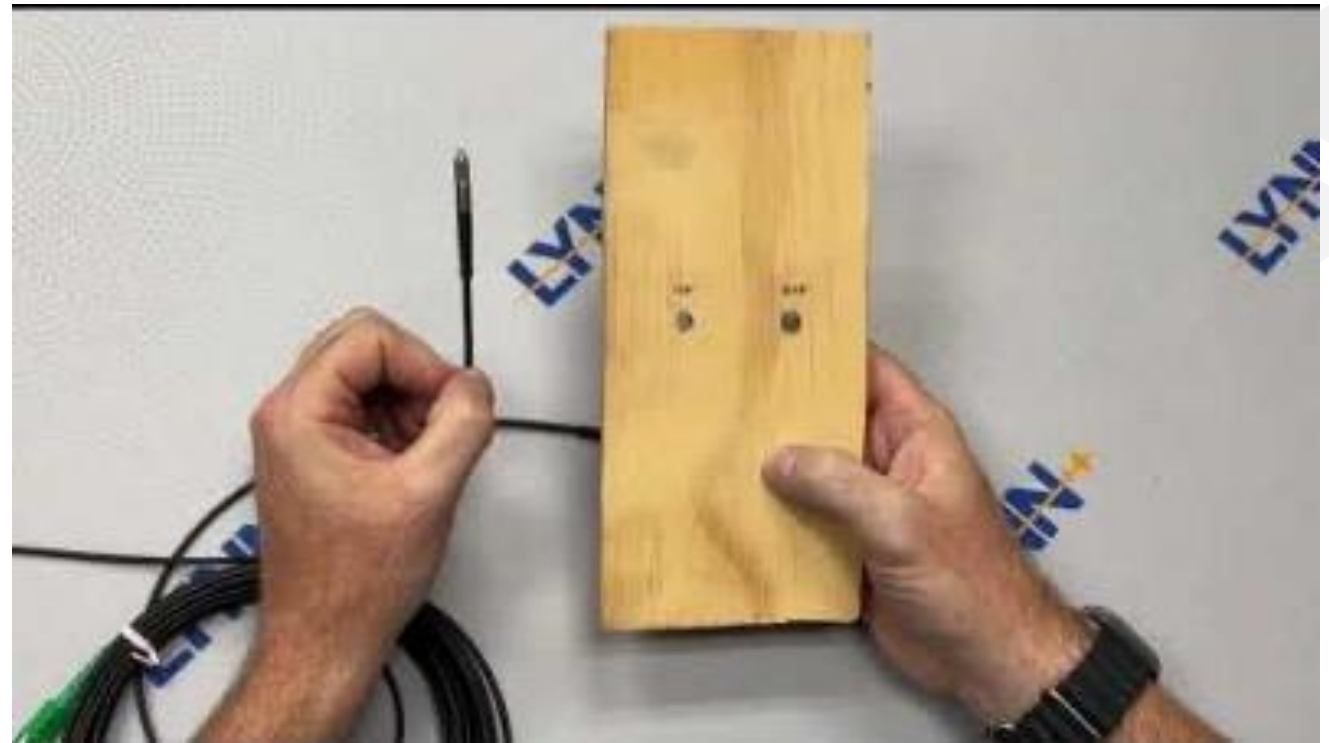

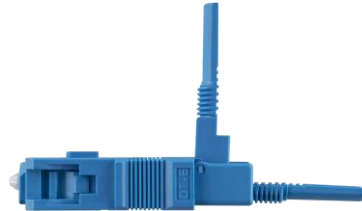
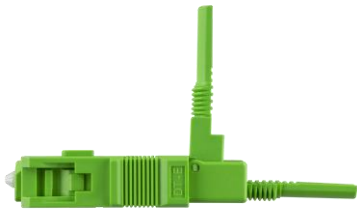

900µm, 2mm, 3mm

Compatible with all three cables sizes

Reusable

Fiber can be reseated

Simple, Fast Installation

No epoxy required. Factory-polished ferrule eliminates polishing in the field.

Low loss

Average: 0.25dB, Maximum: 0.5dB

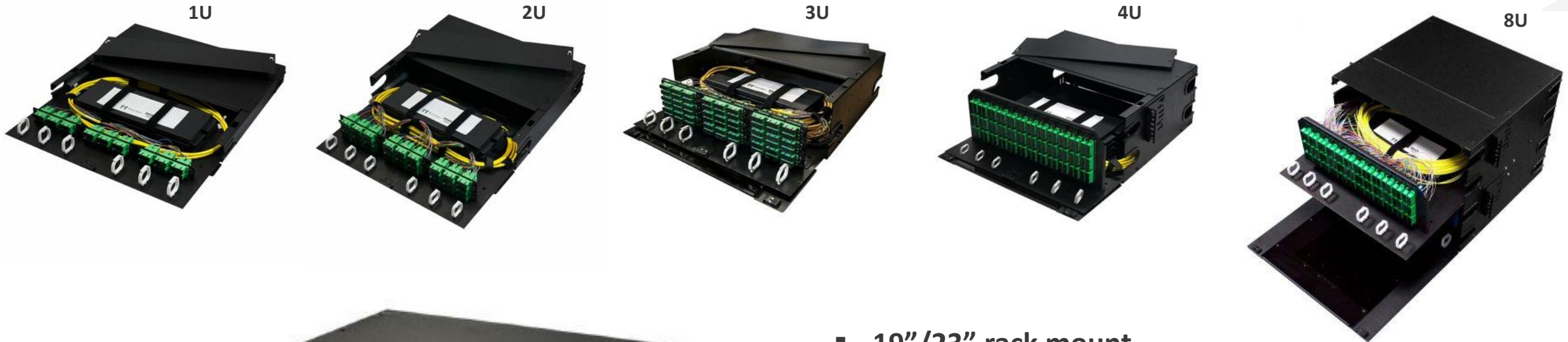

- 19"/23" rack mount
- Slide-out trays
- LGX plates
- Splice tray options
- 1RU – 8RU sizes
- Preloaded for your application

Ideal for Telecom and Premise Installations

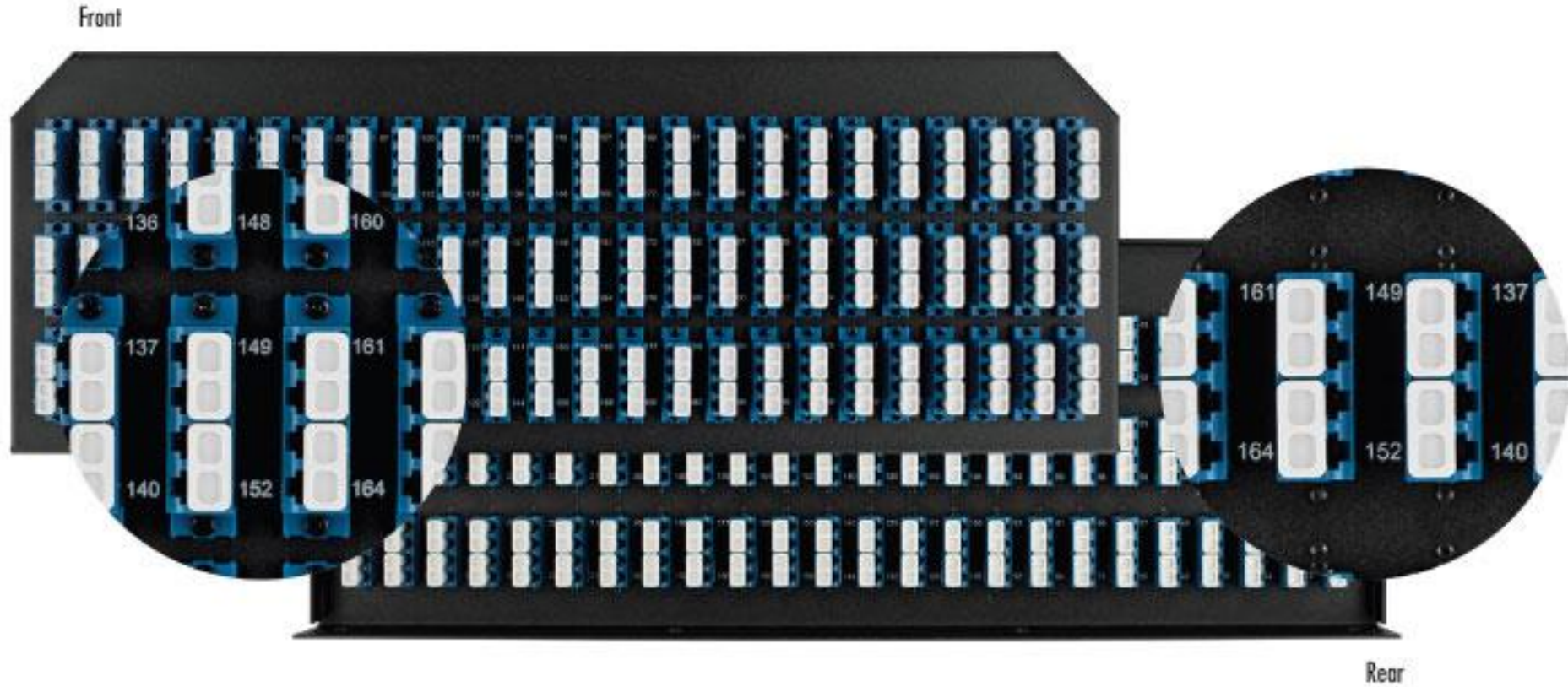

DESIGNED FOR ZAYO

FS.COM Killer!!

1U



2U



3U



- Extreme Density - 33% increase in density compared to standard LGX panel
- Easy Access - Large opening for easy front cable access to each port.
- Up to 144 LC pass through
- 1RU, 2RU, 3RU sizes
- Preloaded for your application



(SC)	1U	2U	3U
LGX	48	96	144
HDA	36	72	108

FIBER PANELS & RACK TRAYS



	CHOICE LGX Panel	Standard LGX Panel	Premium LGX Panel	Premium HDA Panel	BladeHD™ Panel	OptimusMAX / Optimus Panels
PERFORMANCE	GOOD	BETTER	BEST	BEST	BEST	BEST
APPLICATION	STANDARD CABLE MANAGEMENT	STANDARD CABLE MANAGEMENT	STANDARD CABLE MANAGEMENT	HIGH-DENSITY	HIGH-DENSITY EASY SPLICING	HIGH-DENSITY
RACK SIZE OPTIONS	1U	1U	1U / 2U / 3U / 4U / 8U	1U / 2U / 3U	1U / 4U	1U
MAX STRAND SUPPORT	72	72	576	432	288	288
MAX STRAND SUPPORT PER 1U	72	72	72	96	72	288
PANEL INSERT TYPE	LGX	LGX	LGX	HDA/PANDUIT®/FS	BLADEHD™ CASSETTE	NA
SUPPORTS SPLICING	■	■	■	■	■	
SUPPORTS PATCHING	■	■	■	■		■
NON-CAPTIVE MOUNTING EARS	■	■	■	■	■	■
FRONT CABLE PROTECTION		■	■	■	■	
E-Z GLIDE TRAY			■	■		
MAGNETIC DOOR		■	■	■		
E-Z ACCESS REMOVABLE PANELS		■	■	■		
SIDE & REAR CABLE MANAGEMENT			■	■	■	■
OPTIONAL ANGLED FRONT PANEL						■
PART NUMBER	FPP-03-R1-23	FRMP-1U-V2	Multiple SKUs	Multiple SKUs	Multiple SKUs	Multiple SKUs

COPPER PATCH CORDS



ProFIT Slim™

CAT6 & CAT6A (28AWG)

- Quick turn customized solution
- Made in USA & 100% Fluke tested
- Serialized for traceability
- Premium cable & connector with low-profile snagless boot
- 55% smaller diameter

ProFIT™

CAT6 & CAT6A

- Quick turn customized solution
- Made in USA & 100% Fluke tested
- Serialized for traceability
- Premium cable & connector with low-profile snagless boot

Optilink+® Slim

CAT6 & CAT6A (28AWG)

- Quick turn customized solution
- Made in USA
- Low-profile snagless boot
- 55% smaller diameter

Optilink+®

CAT5E, CAT6 & CAT6A

- Quick turn customized solution
- Made in USA
- Low-profile snagless boot

CHOICE Slim™

CAT6 & CAT6A (28AWG)

- Stock lengths & colors
- 55% smaller diameter

CHOICE

CAT5E, CAT6 & CAT6A

- Stock lengths & colors



Standard Jacket



28AWG Slim Jacket

LYNN offers three series of copper patch cords depending on your application. ProFIT™ is designed for the most demanding environments, Optilink+® balances price and performance, and CHOICE delivers a quality cable at a competitive price. All three are available in standard jacket or 28AWG slim constructions.

COPPER PATCH CORD GUIDE



	ProFIT Slim™	ProFIT™	Optilink+® Slim	Optilink+®	CHOICE Slim™	CHOICE
PERFORMANCE	BEST	BEST	BETTER	BETTER	GOOD	GOOD
10G COMPATIBLE	■	■	■	■	■	■
MADE IN USA	■	■	■	■		
CUSTOM LENGTHS & CONFIGURATIONS	■	■	■	■		
28AWG SLIM CONSTRUCTION	■		■		■	
PREMIUM ULTRA FLEXIBLE JACKET	■	■				
PREMIUM CONNECTORS W/ GOLD CONTACTS	■	■				
LOW-PROFILE SNAGLESS BOOT	■	■	■	■	■	
100% FLUKE TESTED	■	■				
SERIALIZED FOR TRACEABILITY	■	■				
AVAILABLE CABLE TYPES	CAT6 / CAT6A	CAT6 / CAT6A	CAT6 / CAT6A	CAT6 / CAT6A / CAT5E	CAT6 / CAT6A	CAT6 / CAT6A / CAT5E
AVAILABLE SHIELDING OPTIONS	UTP	UTP	UTP	UTP / STP	UTP	UTP / STP
AVAILABLE CONDUCTOR OPTIONS	STRANDED	STRANDED	STRANDED	SOLID / STRANDED	STRANDED	STRANDED
JACKET CONSTRUCTION OPTIONS	CMR	CMR	CM / CMP	CM / CMP	CM	CM
AVAILABLE IN MULTIPLE COLORS	■	■	■	■	■	■

[Multiple SKUs](#)

[Multiple SKUs](#)

[Multiple SKUs](#)

[Multiple SKUs](#)

[Multiple SKUs](#)

[Multiple SKUs](#)

RJ45 CONNECTORS

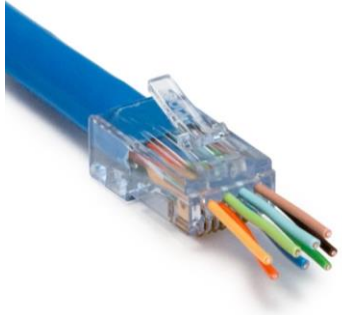

Multiple SKUs

ezEX-RJ45® Connectors

- Patented staggered conductor path & built-in load bar for clean cuts & crimps
- Single piece pass-through RJ45s
- CAT5E, CAT6 & CAT6A
- Shielded & unshielded

Multiple SKUs

EZ-RJ45® Connectors

- Original single piece pass-through RJ45s
- CAT5E & CAT6
- Shielded & unshielded

PLATINUM[®]
TOOLS



106250

CAT7 PoE+ Connector

- Easy-to-terminate shielded design
- Single connector for CAT6, CAT6A & CAT7
- Supports 30W PoE+



Platinum Tools offers the broadest selection of standard, pass-through and snap-on RJ45 connectors in the industry, including the patented EZ-RJ45 and ezEX-RJ45 systems.



106260

CAT6A PoE++ Type 4 Connector

- Easy-to-terminate two-piece design
- Single connector for CAT5E, CAT6 & CAT6A
- Supports 90W PoE++

EZEX-RJ45® CONNECTORS

PLATINUM
TOOLS

NSI
BUILDING
TECHNOLOGY

Regular pass-through RJ45 connectors experience voltage shorting and crosstalk when faced with PoE, 10G and video over twisted pair.

Platinum Tools' revolutionary ezEX -RJ45® system is the only UL-listed pass-through connector for PoE and PoE+ applications with a patented hi-lo stagger design and integrated load bar, delivering quick and reliable termination and future-ready performance.



The most common issue with traditional pass-through connectors is the incomplete trimming of conductors.

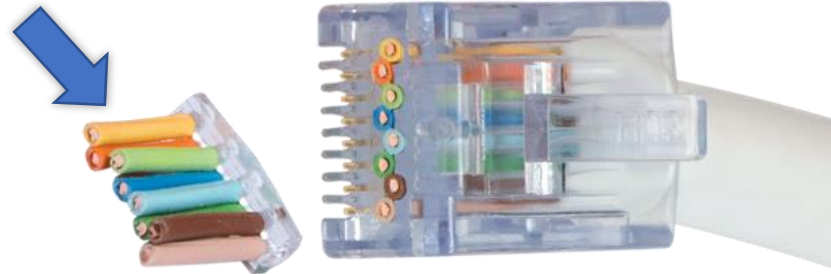

ezEX connectors feature a molded load bar on the nose of the connector that is completely trimmed off during the crimping process, eliminating incomplete trims.

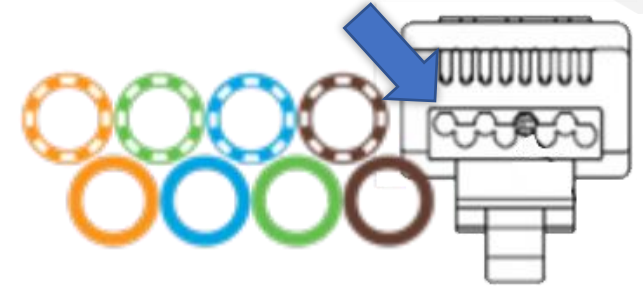

ezEX connectors also feature a staggered wire path reducing near end crosstalk, allowing 10G bandwidth, faster network speeds and the better transmission of voltage.

TOOLS



Multiple SKUs

Crimpers

- Hand-held crimpers for the termination of twisted pair, coax & other low-voltage cables



Multiple SKUs

Punchdown

- Adjustable punchdown tools for the termination of connector blocks



Multiple SKUs

Cutters

- Scissors, pliers & other cutters for the preparation & installation of low-voltage cable



Multiple SKUs

Strippers

- Jacket & conductor strippers for twisted pair, fiber, coax & other low-voltage cables



Multiple SKUs

Screwdrivers

- Multi-function & Specialty screwdrivers for screws & sockets



Platinum Tools specializes in professional-grade tools for the preparation and installation of cable.

PLATINUM[®]
TOOLS



TESTERS

**PLATINUM
TOOLS**



TPS200C **PoE++ Tester**

- Test PoE inline on active devices
- Test DC power supplies
- No power supply required



TDG310K1C **Digital Tone & Probe Kit**

- Trace & locate cables
- Test RJ45 terminations
- Built-in signal strength indicators



TP500C **LANSeeker™ Tester**

- Test shorts, opens, miswires, reverse & split pairs
- Built-in tone generator



T109C **MapMaster™ mini Tester**

- Test shorts, opens, miswires, reverse & split pairs
- Built-in tone generator
- Map multiple locations



T130K1 **VDV MapMaster 3.0™ Tester**

- Test shorts, opens, miswires, reverse & split pairs
- Measure fault & cable length
- Map multiple locations



TNC950AR **Net Chaser™ Certifier & Tester**

- Advanced ethernet speed certification & network testing
- Map & view network layout & interfaces
- Save & print reports

TESTER GUIDE



	Pocket PoE++ Tester	Digital Tone & Probe	LANSeeker™ Tester	MapMaster™ mini Pocket Tester	VDV MapMaster 3.0™ Tester	Net Chaser™ Certifier & Tester
ETHERNET SPEED CERTIFICATION (1G)						■
BIT ERROR RATE & SKEW TESTING						■
SIGNAL TO NOISE RATIO TESTING						■
VLAN & PORT DISCOVERY						■
ACTIVE ETHERNET LINK & DHCP TESTING						■
NETWORK MAPPING & TRACEROUTE TESTING						■
POE TESTING	■					■
POWER SUPPLY VOLTAGE TESTING	■					
LINK LIGHT TESTING					■	■
ONE ENDED TESTING			■		■	■
TONE GENERATION		■	■	■	■	■
MANUAL CABLE TRACING		■				
LENGTH DETECTION TO OPEN					■	■
LENGTH DETECTION TO SHORT						■
CONNECTOR CONTINUITY VERIFICATION	■	■	■	■	■	■
ID REMOTE SUPPORT			1 REMOTE	5 REMOTES	20 REMOTES	20 REMOTES
TESTING PORT TYPES	RJ45 / 5.5mm DC	RJ45 / BNC	RJ45	RJ45	RJ45 / F / RJ11	RJ45 / F

PART NUMBER

[TPS200C](#)

[TDG310K1C](#)

[TP500C](#)

[T109C](#)

[T130K1](#)

[TNC950AR](#)

J-HOOKS & CABLE MANAGEMENT

PLATINUM[®]
TOOLS



Multiple SKUs

High-Performance J-Hooks

- Hybrid steel & plastic construction
- Smooth plastic for easy cable slide
- Wide design reduces cable sag
- Built-in retainer strap
- Four color options to segregate cable runs
- Multiple sizes & pre-assembled mounting options



Multiple SKUs

Standard J-Hooks

- Construction-grade, multi-purpose
- All steel construction
- Multiple sizes & pre-assembled mounting options



Multiple SKUs

Bridle Rings

- Construction-grade, multi-purpose
- All steel construction
- Multiple sizes
- Threaded & wood screw options



Platinum Tools HPH Series High-Performance Hybrid J-Hooks feature a metal outer frame for strength and a plastic inner frame for support, protection and easy cable pulling. A built-in retainer strap and four available color options simplify cable installation and management.

KEYSTONES



Multiple SKUs

110 Type Keystone Jacks

- 110 punch punchdown termination
- Unshielded CAT5E, CAT6 & CAT6A
- Multiple colors

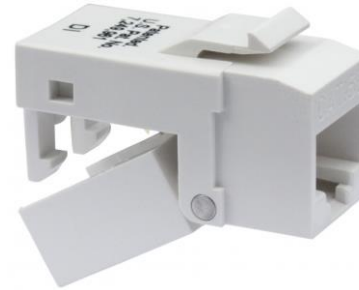

Multiple SKUs

EZ-SnapJack™

- Self-terminating, no tool required
- Re-useable
- Unshielded CAT5E & CAT6
- Multiple colors



Multiple SKUs

Toolless Keystone Jacks

- Self-terminating, no tool required
- Re-useable
- CAT5E, CAT6 & CAT6A
- Shielded & unshielded
- Multiple colors



Platinum Tools offers a wide variety of punchdown and keystone rapid termination tools that increase termination speeds up to 90%.

KEYSTONE MANAGEMENT



[PRO-CPP-BLANK-1U-48V](#)

ProFIT 1U 48 Port Angled Jack Panel

- 48 keystone ports in 1U footprint
- Angled design for high-density applications
- Front & rear port labeling
- Built-in cable management
- Flush fit keystone mounting to protect from damage

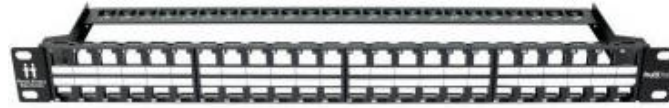

[PRO-CPP-BLANK-1U-48](#)

ProFIT 1U 48 Port Jack Panel

- 48 keystone ports in 1U footprint
- Front & rear port labeling
- Built-in cable management
- Flush fit keystone mounting to protect from damage



[PRO-CPP-BLANK-2U-48](#)

ProFIT 2U 48 Port Jack Panel

- 48 keystone ports in 2U footprint
- Front & rear port labeling
- Built-in cable management
- Flush fit keystone mounting to protect from damage



[PRO-CPP-BLANK-1U-24](#)

ProFIT 1U 24 Port Jack Panel

- 24 keystone ports in 1U footprint
- Front & rear port labeling
- Built-in cable management
- Flush fit keystone mounting to protect from damage



[Multiple SKUs](#)

110 Type Loaded Jack Panels

- 24 port 1U & 48 port 2U options
- Front & rear port labeling
- Built-in cable management



[LGX-6-KEY](#)

Keystone LGX Adapter Panel

- Compatible with LGX rack mount and wall mount enclosures typically used in fiber optic installations
- Facilitates a streamlined, hybrid installation

WEATHER-RATED INSTALLATION



[744](#)

Weatherproof Coupler Housing

- IP64 rated
- Compatible with twisted pair, fiber & coax
- Supports keystone & barrel couplers



[740C](#)

Waterproof Splice Coupler

- IP67 rated
- Screw mating system
- Compatible with UTP & STP CAT6



[745-1](#)

Weatherproof Keystone Jack

- IP64 rated
- Installs in any 1" knockout or threaded hole
- Compatible with UTP & STP Cat6



Platinum Tools weather-rated solutions manage and secure connections and splices in environments exposed to water, dust, corrosion and vibration.

NETWORKING ELECTRONICS



Multiple SKUs

SFP Transceivers / mini-GBICs

- 1G & 10G bandwidth
- Simplex & duplex LC connection
- Universal EEPROMs for compatibility with most manufacturers



Multiple SKUs

PoE Injectors

- Inject up to 60W PoE onto cable runs
- 1G bandwidth



Multiple SKUs

PoE Extenders

- Extend 30W PoE beyond 330ft
- Cascade up to 5 units
- 1G bandwidth
- Indoor & outdoor options



Multiple SKUs

Media Converters

- 1G & 10G bandwidth
- PoE & non-PoE
- LC & SC connection



TL-RKMC-14

Media Converter Rack Mounting

- Secure & power up to 14 media converters
- 2RU height
- Built-in cooling & circuit protection



Multiple SKUs

Network Switches

- Unmanaged with 1G bandwidth
- PoE & non-PoE
- Desktop & rack mount
- Fiber & copper connectivity

ELECTRICAL TAPE



BUILDING
TECHNOLOGY



832 Series

Heavy-Duty Performance

- 8.5 mil thickness
- Resistant to UV, abrasion & corrosion
- 0 – 221°F operating temperature



732 Series

Professional+ Performance

- 7 mil thickness
- Resistant to UV, abrasion & corrosion
- 0 – 221°F operating temperature



722 Series

Professional Performance

- 7 mil thickness
- Resistant to UV, abrasion & corrosion
- 20 – 176°F operating temperature



716 Series

General Use Performance

- 7 mil thickness
- Resistant to UV, abrasion & corrosion
- 20 – 176°F operating temperature



Whether you are bundling, insulating, splicing or simply need protection against corrosion, UV or moisture, WarriorWrap® outperforms whatever tape you've been using.

OTHER PRODUCTS

POLARIS®



Submersible Pedestal Connector

- Direct Burial Applications
- One-Side Wire Entry
- Squared-Off Design
- Pre-filled Oxide Inhibitor
- Professional Performance

POWER GRIP®
CABLE TIES



Self-Locking Head

Grips Tightly
and Securely



Curved Tip

for Faster
Threading



Strong Teeth

Lock in Place

74 SKUs

Operating Temperature: - 40°C to 85°C

MATERIALS

- Suitable for Plenum spaces
- Nylon 6,6 in natural and in UV weather resistant black
- Black UV suitable for outdoor use



800-523-6075 | North Wales, PA

ThinkLynn.com | PlatinumTools.com | TLNetworx.com | NSIIndustries.com